



# Cambridge IGCSE™

CANDIDATE  
NAME

CENTRE  
NUMBER

--	--	--	--	--

CANDIDATE  
NUMBER

--	--	--	--

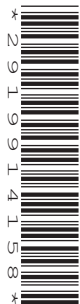

**PHYSICAL SCIENCE**

**0652/32**

Paper 3 Theory (Core)

**October/November 2020**

**1 hour 15 minutes**

You must answer on the question paper.

No additional materials are needed.

## INSTRUCTIONS

- Answer **all** questions.
- Use a black or dark blue pen. You may use an HB pencil for any diagrams or graphs.
- Write your name, centre number and candidate number in the boxes at the top of the page.
- Write your answer to each question in the space provided.
- Do **not** use an erasable pen or correction fluid.
- Do **not** write on any bar codes.
- You may use a calculator.
- You should show all your working and use appropriate units.

## INFORMATION

- The total mark for this paper is 80.
- The number of marks for each question or part question is shown in brackets [ ].
- The Periodic Table is printed in the question paper.

This document has **20** pages. Blank pages are indicated.

1 A mixture contains four components.

Table 1.1 gives information about the four components of this mixture.

**Table 1.1**

component	information
ethanol	colourless liquid dissolves in water boils at 78 °C
salt	white solid soluble in water
sand	off-white solid does not dissolve in water or ethanol
water	colourless liquid boils at 100 °C

Fig. 1.1 shows a method of separating one component from the mixture.

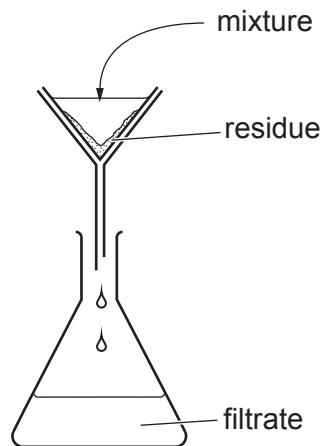

**Fig. 1.1**

(a) (i) Name the component collected as the residue on the filter paper.

..... [1]

(ii) One sample of the filtrate is distilled.

Name the first component collected from the distillation.

Give a reason for your answer.

component .....

reason .....

..... [2]

(iii) Another sample of the filtrate is evaporated to dryness.

Name the component left behind.

..... [1]

(b) Describe a test to show that the original mixture contains water.

test .....

positive result .....

[2]

[Total: 6]

2 Fig. 2.1 shows the motion of a car on a straight horizontal road.

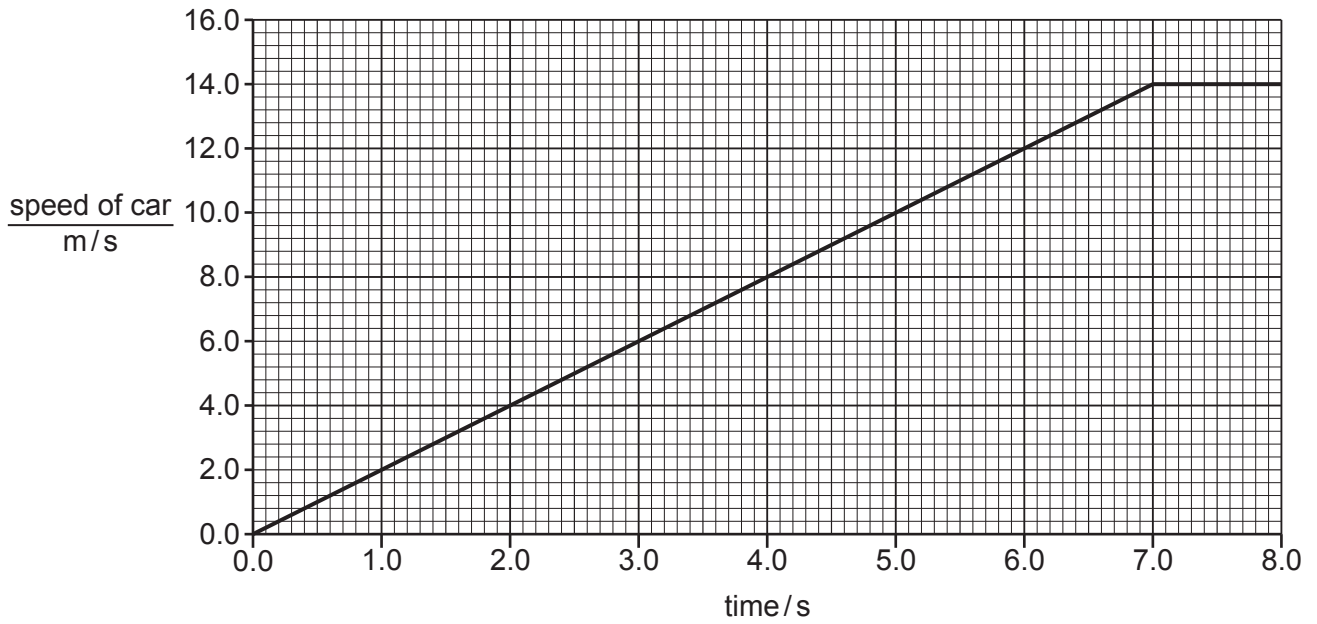

**Fig. 2.1**

(a) Describe the motion of the car during the first 7.0 s.

.....  
 ..... [2]

(b) Use Fig. 2.1 to determine:

(i) the speed of the car at 5.0 s

speed = ..... m/s [1]

(ii) the distance travelled by the car in the first 6.0 s.

distance = ..... m [2]

(c) Lights are used to stop cars to allow people to cross the road safely.

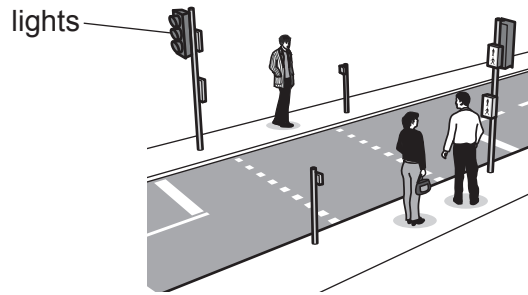

Fig. 2.2

Table 2.1 shows the walking speeds of four different people A, B, C and D.

Table 2.1

person	average walking speed m/s
A	1.6
B	1.4
C	0.8
D	1.0

(i) State which person takes most time to cross the road.

..... [1]

(ii) The road is 8.0m wide.

Calculate the time taken for the person given in your answer to (i) to cross the road.

time = ..... s [2]

(iii) Suggest why the lights stop the cars for more time than is needed for the slowest person to cross the road.

.....  
 ..... [1]

[Total: 9]

- 3 Sodium is an element in Group I of the Periodic Table.

Table 3.1 gives some information about an atom of sodium.

**Table 3.1**

number of electrons	11
number of protons	.....
nucleon number	23
number of neutrons	.....

- (a) Use the information in Table 3.1 to determine the values of the missing numbers.

Record these values in Table 3.1. [2]

- (b) Write the electronic structure of an atom of sodium to show the number of electrons in each shell.

..... [2]

- (c) Sodium reacts with chlorine to form the ionic compound, sodium chloride.

- (i) Balance the equation for this reaction.

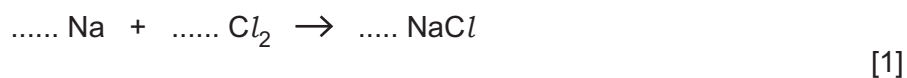

- (ii) Complete Table 3.2 to give the names and formulae of the two ions in sodium chloride.

**Table 3.2**

name of ion	formula of ion

[2]

[Total: 7]

- 4 (a) A student observes a coin in a metal bowl.

A ray of light from the coin enters the student's eye, as shown in Fig. 4.1.

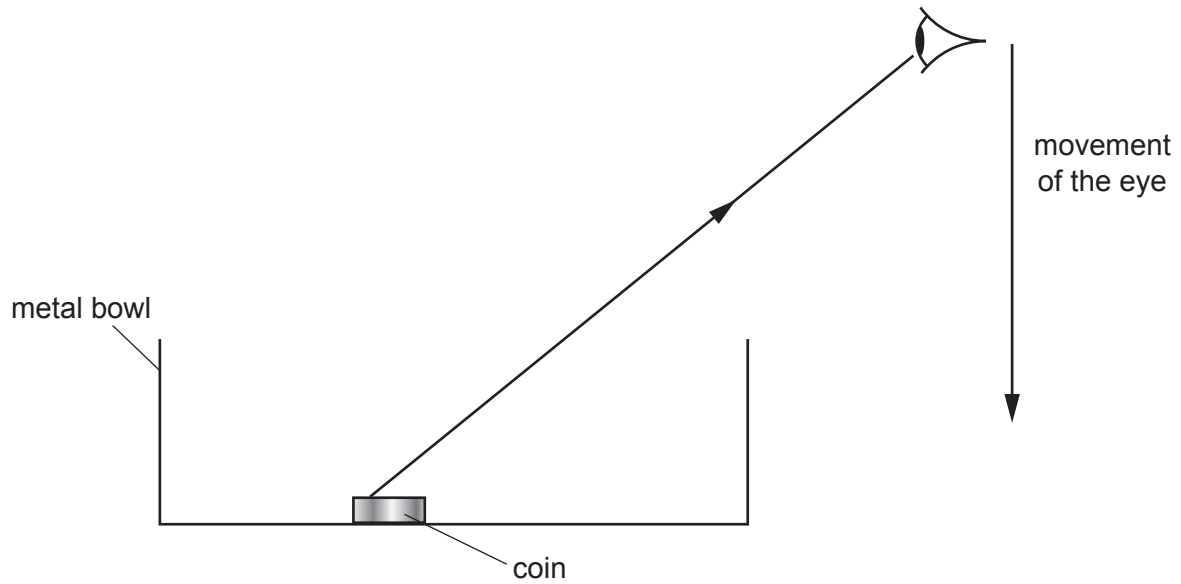

Fig. 4.1

The student moves his eye down until he can no longer see the coin.

On Fig. 4.1, draw another ray of light from the coin to the position of the eye just before the coin disappears from view. [1]

- (b) The bowl is filled with water.

The ray of light **R** from the coin leaves the surface of the water as shown in Fig. 4.2.

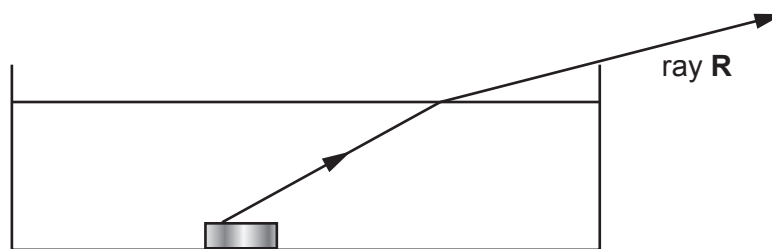

Fig. 4.2

On Fig. 4.2:

1. draw the normal where ray **R** leaves the water
2. label the angle of incidence with  $i$ .

[2]

(c) Fig. 4.3 shows an image of an object.

The image is produced by a lens.

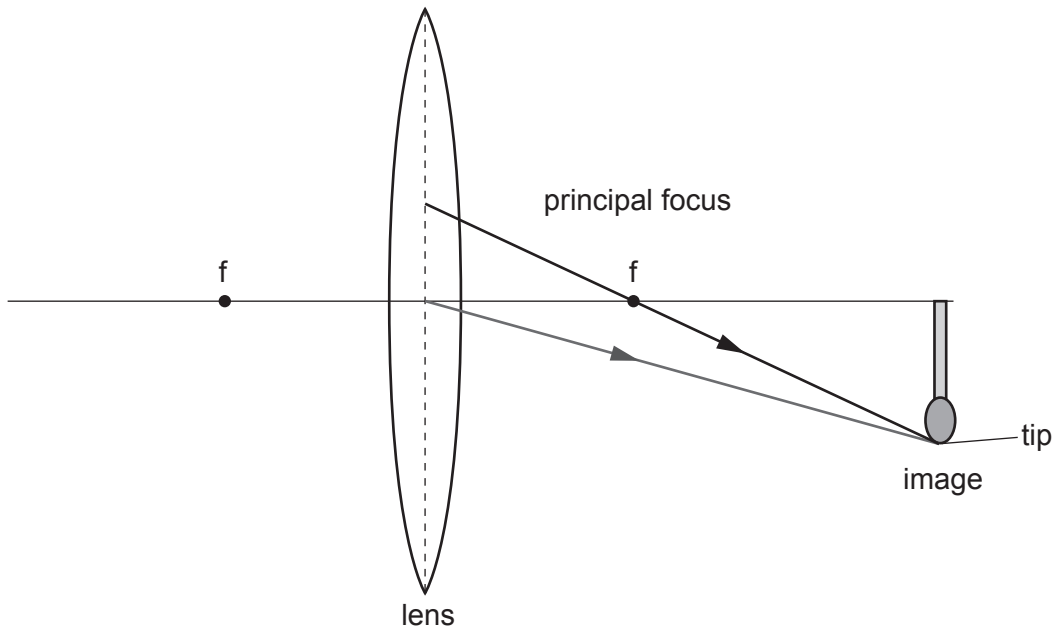

**Fig. 4.3**

(i) Name the type of lens shown.

..... [1]

(ii) On Fig. 4.3, extend the two rays backwards until they cross. [2]

(iii) On Fig. 4.3, draw the object and label it **O**. [2]

[Total: 8]



5 Carbon is an element which exists in different forms.

Graphite is one of these forms.

(a) (i) Describe the structure of graphite.

.....  
 .....  
 .....  
 ..... [2]

(ii) Graphite is a good thermal conductor.

Describe **one** other property of graphite.

..... [1]

(b) Name another form of carbon.

..... [1]

(c) Carbon is used as a fuel when it burns in air.

(i) Name the gas found in air which reacts with carbon.

..... [1]

(ii) Write a word equation for this reaction.

..... [1]

(d) Name a metal that can be extracted from its ore using carbon.

..... [1]

(e) Carbon forms compounds with hydrogen.

(i) Give the name and formula of the compound of carbon and hydrogen which contains only one carbon atom.

name .....

formula .....

[2]

(ii) Give the name used to describe compounds which contain carbon and hydrogen only.

..... [1]

[Total: 10]

6 Four radioactive sources are investigated.

Each source is placed in front of a detector, as shown in Fig. 6.1, and left for one minute.

After one minute the count is recorded.

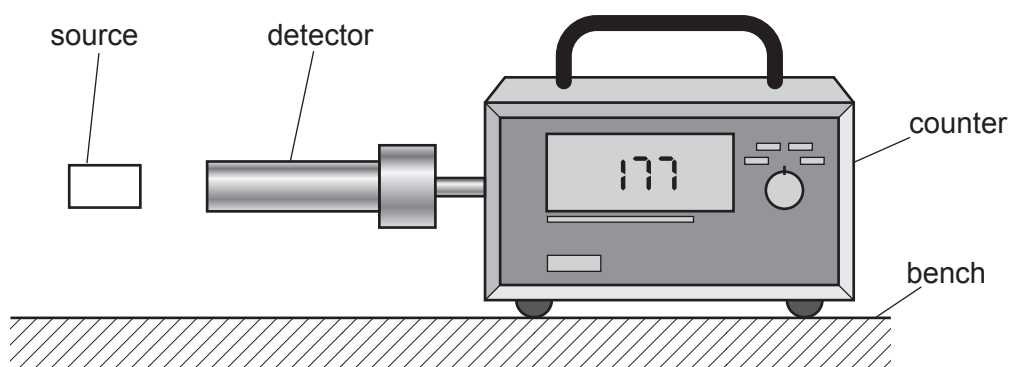

Fig. 6.1

The measurement is repeated with different absorbing materials placed between the source and the detector, as shown in Fig. 6.2.

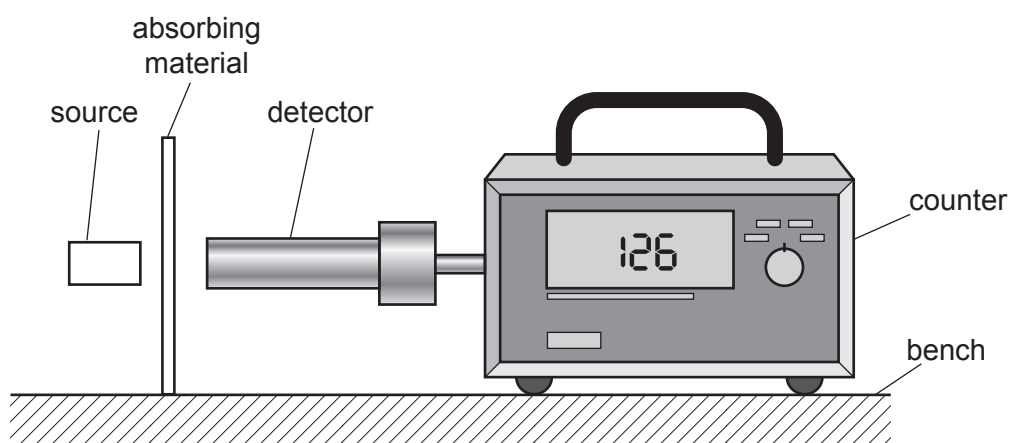

Fig. 6.2

The counts for one minute using different absorbing materials are shown in Table 6.1.

Table 6.1

source	count with no absorbing material	count for thin paper	count for thin metal foil	count for thick steel
<b>A</b>	902	899	26	24
<b>B</b>	906	524	522	130
<b>C</b>	900	25	22	28
<b>D</b>	909	912	901	247

(a) Three of the sources each emit **one** type of radiation only.

The other source emits **two** types of radiation.

Circle the letter corresponding to the source which emits:

- |                                    |          |          |          |          |     |
|------------------------------------|----------|----------|----------|----------|-----|
| • gamma radiation only             | <b>A</b> | <b>B</b> | <b>C</b> | <b>D</b> |     |
| • alpha radiation only             | <b>A</b> | <b>B</b> | <b>C</b> | <b>D</b> |     |
| • more than one type of radiation. | <b>A</b> | <b>B</b> | <b>C</b> | <b>D</b> | [3] |

(b) Use the data in Table 6.1 to deduce an approximate value for the background radiation.

..... [1]

(c) The experiment is repeated using exactly the same conditions.

All the counts are different in this repeated experiment.

Some are slightly higher and some are slightly lower.

State why the counts are different.

.....  
..... [1]

[Total: 5]

- 7 (a) Electrolysis is used to break down ionic compounds.

Complete Table 7.1.

**Table 7.1**

ionic compound electrolysed	anode product	cathode product
molten lead bromide	bromine	.....
dilute sulfuric acid	.....	hydrogen

[2]

- (b) Fig. 7.1 shows how some metals react with dilute sulfuric acid.

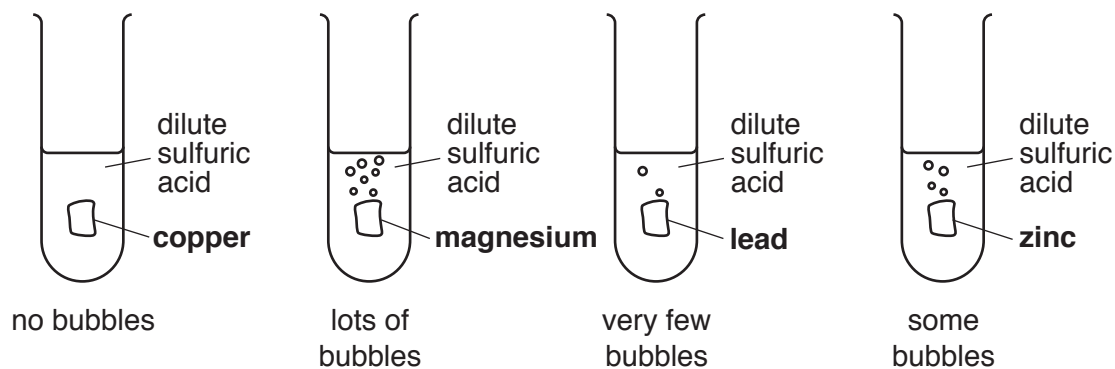

**Fig. 7.1**

Use Fig. 7.1 to determine the order of reactivity of these four metals.

most reactive .....

.....

.....

least reactive .....

↑

[2]

[Total: 4]

8 Fig. 8.1 shows a dumper truck full of sand.

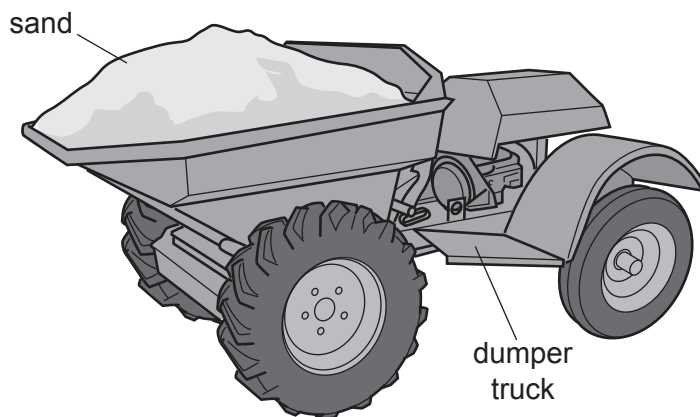

Fig. 8.1

The mass of the sand is 800 kg.

(a) (i) The density of sand is  $1600 \text{ kg/m}^3$ .

Calculate the volume of the sand.

volume of sand = .....  $\text{m}^3$  [2]

(ii) Calculate the weight of the sand and state the unit.  
 [ $g = 10 \text{ N/kg}$ ]

weight of sand = ..... unit ..... [2]

(b) The dumper truck carries the sand to the top of the hill.

(i) State the form of energy gained by the sand.

..... [1]

(ii) The dumper truck uses diesel fuel. State the type of energy stored in the fuel.

..... [1]

(c) Circle the correct underlined word or phrase to complete the following sentence.

When the dumper truck moves the same weight of sand to the top of the hill in less time, it uses ( more / the same / less ) power. [1]

[Total: 7]

9 (a) The formula of ammonium nitrate is  $\text{NH}_4\text{NO}_3$ .

(i) State the number of nitrogen atoms in the formula of ammonium nitrate.

..... [1]

(ii) State the total number of atoms in the formula of ammonium nitrate.

..... [1]

(b) Ammonium nitrate is made by neutralising an acid with aqueous ammonia.

(i) Name the acid used.

..... [1]

(ii) Describe a test to show the acid is neutralised.

test .....

positive result .....

[2]

(c) Ammonium nitrate is added to soil as a fertiliser.

Farmers also add limestone to soil even though it is **not** a fertiliser.

Explain why limestone is added to soil .

.....

.....

..... [2]

[Total: 7]

10 A girl rubs a balloon on her hair.

The balloon becomes negatively charged.

(a) Explain in terms of movement of particles why the balloon is negatively charged.

.....  
 ..... [2]

(b) A second balloon is charged in the same way.

The two balloons are suspended near each other using nylon thread.

Fig. 10.1 shows some ways in which the balloons may hang when they are suspended.

(i) Circle the diagram which shows how the balloons hang. [1]

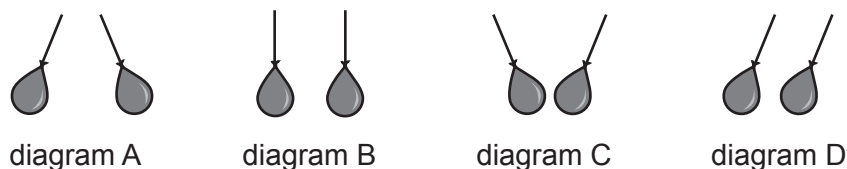

Fig. 10.1

(ii) Explain why the balloons hang in this way.

.....  
 ..... [1]

(c) The girl's hair also becomes charged when she rubs the balloon on her hair. One of the negatively charged balloons is suspended near the girl's head.

Circle the diagram in Fig. 10.2 which shows how the balloon hangs and affects her hair.

Give a reason for your choice.

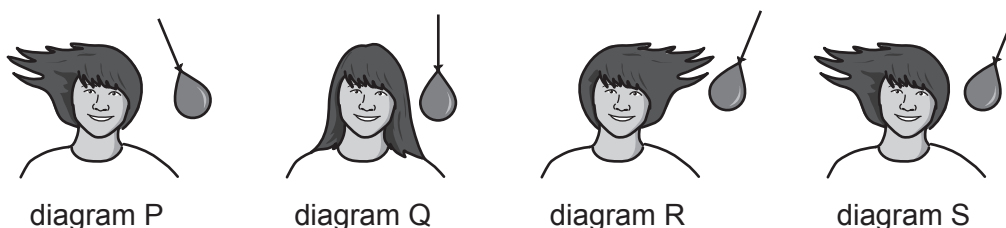

Fig. 10.2

Reason .....  
 ..... [2]

[Total: 6]

11 Ethene, C<sub>2</sub>H<sub>4</sub>, is an unsaturated compound.

(a) State why ethene is described as an *unsaturated* compound.

.....  
..... [2]

(b) Ethene is obtained from petroleum using a two stage process.

(i) **stage 1:** petroleum is separated into its components.

Name the process used in stage 1.

..... [1]

(ii) **stage 2:** one of the components from stage 1 is used to produce ethene.

Name the process used in stage 2.

..... [1]

(c) Draw the structure of ethene showing all of the atoms and all of the bonds.

[2]

[Total: 6]



12 Fig. 12.1 shows a simple loudspeaker.

A coil of insulated wire is taped to a plastic sheet. The sheet is then attached to a paper cup containing a bar magnet.

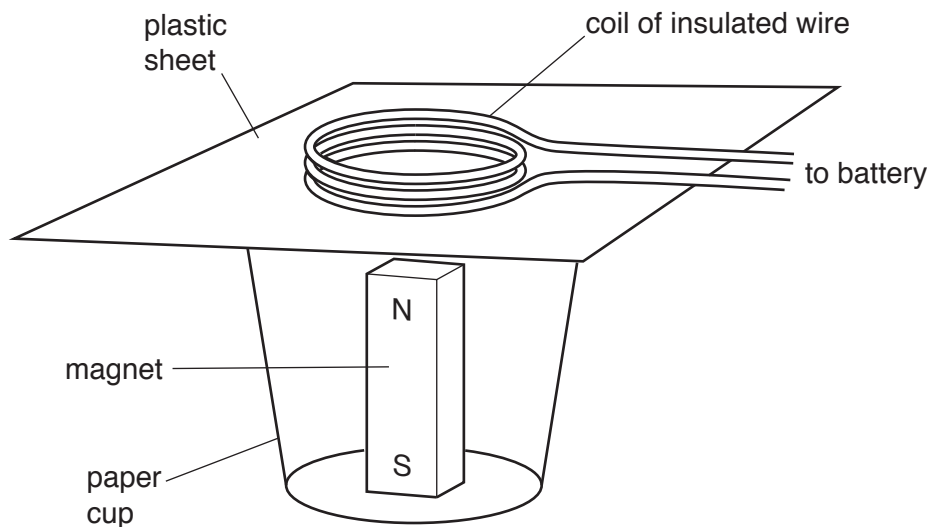

Fig. 12.1

(a) (i) When the coil is connected to a battery, the plastic sheet moves upwards.

Explain why the plastic sheet moves upwards.

.....  
 ..... [2]

(ii) The connections to the battery are reversed so that the current is reversed.

Explain why the plastic sheet now moves down.

.....  
 ..... [1]

(b) The coil is connected to an a.c. supply.

The current changes direction 50 times each second.

Explain how the plastic sheet produces a sound.

.....  
 ..... [2]

[Total: 5]



**BLANK PAGE**

---

Permission to reproduce items where third-party owned material protected by copyright is included has been sought and cleared where possible. Every reasonable effort has been made by the publisher (UCLES) to trace copyright holders, but if any items requiring clearance have unwittingly been included, the publisher will be pleased to make amends at the earliest possible opportunity.

To avoid the issue of disclosure of answer-related information to candidates, all copyright acknowledgements are reproduced online in the Cambridge Assessment International Education Copyright Acknowledgements Booklet. This is produced for each series of examinations and is freely available to download at [www.cambridgeinternational.org](http://www.cambridgeinternational.org) after the live examination series.

Cambridge Assessment International Education is part of the Cambridge Assessment Group. Cambridge Assessment is the brand name of the University of Cambridge Local Examinations Syndicate (UCLES), which itself is a department of the University of Cambridge.

